

Varenummer: 207321M567NI  
Beskrivelse: E+G Pasbolt  
GN 732.1-M5-6-7-NI

## Mål

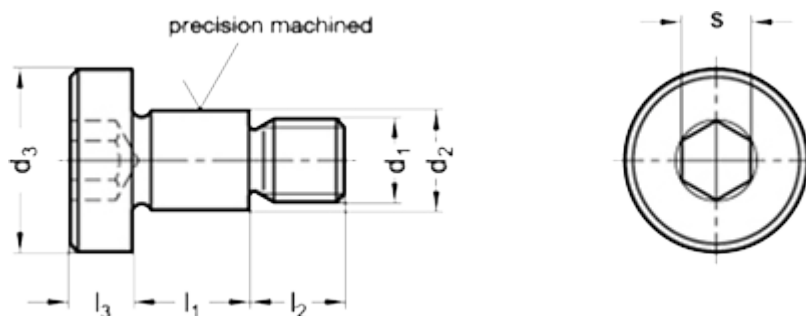

### Application example



d1	= M 5
d2	= 6 -0.03/-0.05
d3	= 12
l1 +0.20/+0.13	= 7
l2	= 7
l3	= 3
s	= 3
Vægt i (g)	= 5